

trinityglazing Energy Rated Windows



trinityglazing Ltd

glass and glazing services

Supplied by:
Trinity Glazing

Subject to Trinity Glazing Terms and Conditions
Copyright © 2011 Trinity Glazing

Trinity Glazing Ltd
Units 29 & 30
Stewartfield Industrial Estate
Edinburgh
EH6 5RQ

T: 0131 555 3539
F: 0131 450 7132

E: info@trinityglazing.co.uk
W: www.trinityglazing.co.uk

*Please check ratings with Trinity before ordering. Brochure Version 2 November 2010
Images for illustration purposes only. Terms and Conditions apply.

trinityglazing Ltd

glass and glazing services

Energy Rated Windows



Trinity 60mm System

Trinity 60C

With an extensive range of colour choices and style options, 60C is our most popular profile range and is suitable for both new build and replacement frames.

The 60C frame has a chamfered finish with a choice of two types of beading: sculptured and chamfered. Chamfered has clean, smooth and modern edging, whilst sculptured has the appearance of a traditional sculpted frame.

The 60C frame gives the widest choice of frame colour options, from traditional oak and mahogany to contemporary black, all with authentic grain-effect finishes.

Available in casement windows, Tilt N Turns, mini-French windows and special frames.

- 60mm profile
- Chamfered frame
- Chamfered or sculptured beading
- 24mm glazing and beading
- 28mm glazing/beading optional extra
- Internally or externally glazed
- 13 Colour Choices
- Integral, colour coordinated gaskets
- Espagnolette Bolt Locking available
- Available with BSI "A", "B" & "C" ratings*

Trinity 60S

The 60S profile has been fabricated specifically for Trinity Glazing to allow customers more choice when choosing their frames.

The 60S frame has a sculptured finish with a matching sculptured beading. Sculptured profile has a more curved appearance giving the frames extra character. Available in 3 classic colours: white, mahogany and oak.

Featuring 4 internal chambers within the profile, this further adds to the thermal efficiency of the frame.

The 60S is available in casement windows, mini-French windows and special frames.

- 60mm profile
- Fully sculptured frame and beading
- 4 Internal chambers
- 24mm glazing and beading
- 28mm glazing/beading optional extra
- Internally Glazed
- 3 Colour Options
- Integral, colour coordinated gaskets
- Espagnolette Bolt Locking available
- Available with BSI "B" rating*

"Trinity 60C... our most popular frame, with a smooth finish"



"Trinity 60S... with 4 internal chambers, and a shaped finish"



Trinity eCare Energy Rated Windows

Trinity "A" Rated Window

Energy Rating	A
Whole Window u-value	1.40
Frame Profile	60C, 70C & 70S
Glazing Size	4/16/4 (60mm) & 4/20/4 (70mm)
Outer Glass	Low Iron
Gas Fill	Argon
Inner Glass	Low E Soft Coat
Spacer Bar	Warm Edge Super Spacer
Solar Gain	0.68g
Light Transmission	80%



Reinforcement: full or partial depending on colour Outerframe: 52 or 62mm depending on profile

Trinity "B" Rated Window

Energy Rating	B
Whole Window u-value	1.40- 1.45
Frame Profile	60C & 60S
Glazing Size	4/16/4
Outer Glass	Float
Gas Fill	Argon
Inner Glass	Low E Soft Coat
Spacer Bar	Warm Edge Super Spacer
Solar Gain	0.63g
Light Transmission	78%

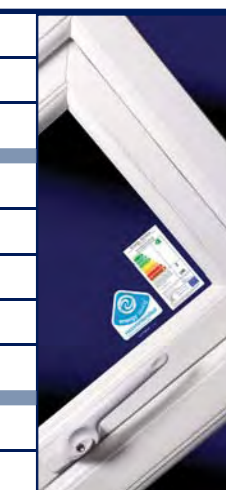

Reinforcement: full or partial depending on colour Outerframe: 52 or 62mm depending on profile

"C" ratings now available in 70C profile using either Float/Argon/Low E Soft Coat/Aluminium Spacer or Float/Argon/Hard Coat/Warm Edge

Energy Efficient Glass...

Float Glass:

- Standard glass found in many double glazed units

Low Iron Glass:

- Clear, neutral appearance
- Excellent light transmission
- "A" rating when combined with Low E Soft Coat

Low E Soft Coat Glass:

- Enhanced thermal insulation
- Excellent light transmission
- "A" rating when combined with Low Iron

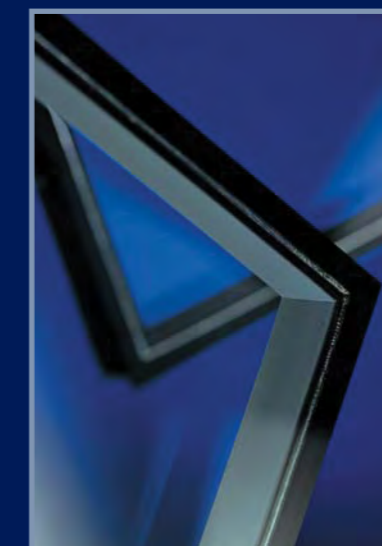

Spacer Bar & Gas Fill...

Warm Edge Spacer:

- Foam-based spacer bar
- Heat loss reduced by up to 94%
- Reduces condensation by up to 70%

Argon Gas:

- Reduces convection (the transfer of heat)
- Ensures extra insulation
- Argon raises the overall glass temperature, helping to eliminate condensation



Whole window u-values may vary with individual window dimensions.

What are Energy Rated Windows?

Trinity 70mm System

Single and old double glazing results in major heat loss within the home. Upgrading to energy efficient windows will greatly reduce heat loss, keeping your home warmer and reducing CO₂ emissions.

Trinity Glazing's range of Energy Rated Windows has been designed to minimise heat loss, absorb heat from the sun and eliminate air leakage... the result is savings on home heating bills and reduced energy waste.

Trinity Energy Rated Windows are tested and certified by the British Standards Institute and approved by the Energy Saving Trust scheme.

The energy efficiency of windows are measured by Window Energy Ratings. WER's take into account the performance of both frame and glass known as a whole window ratings, and are determined by three main factors:

- 1) Thermal Transmittance (U-window):** measures heat that is lost through the overall window - energy efficient windows reduce heat loss, therefore a lower u-window value means better energy efficiency.
- 2) Heat Gain (G-window):** measures the amount of heat that is absorbed from the sun - energy efficient windows transmit solar heat back into the room (helping to lower home-heating usage).
- 3) Air Leakage/Loss (L-factor):** measures heat loss that occurs as a result of general air leakage - an energy efficient frame and glass will help reduce air leakage.

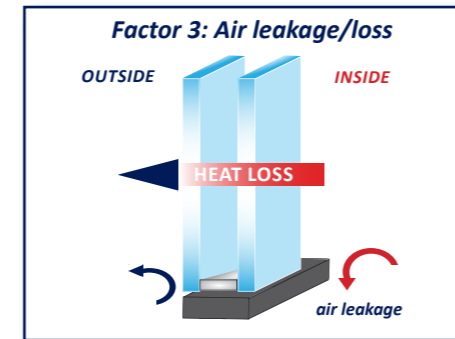
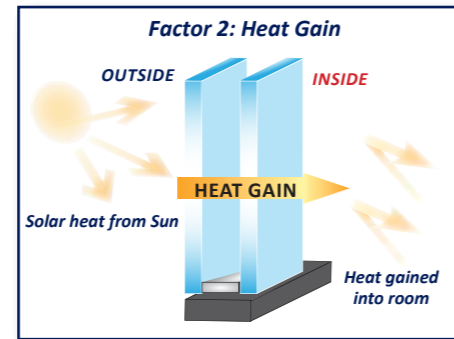
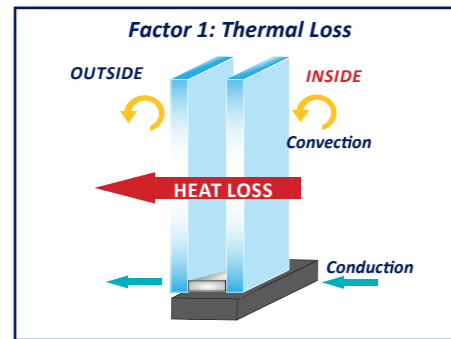
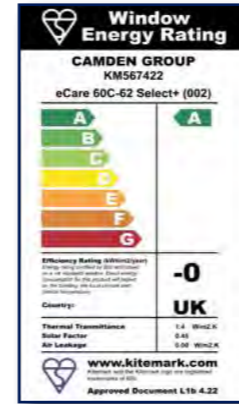

Energy Rated Windows - the benefits for home owners:

- 1) Save money on your home heating bills...** your heating bills could be reduced by up to 20% per year.
- 2) The Environment...** energy efficient windows will help ensure you do "your bit" for the environment and could reduce your CO₂ emissions by up to two tonnes.
- 3) Current building regulations...** energy efficient windows adhere to currently building regulations for new build properties and houses for sale or rent. If you are selling your home, energy rated windows could help add to the overall value of the property.



Trinity 70C

The 70C frame range, fabricated from 70mm profile, is suitable for both new build and replacement frames and allows customers extra choice.

The 70C frame is chamfered on both sides giving a smooth and modern edging, and with the option of chamfered or sculptured beading. Available in white, rosewood and oak.

The 70mm profile offers you extra which can be useful when replacing old frames; the wider 70mm frame can help cover the untidy lines left behind by old frames.

Available in casement windows, Tilt N Turns, mini-French windows and special frames.

- 70mm Profile
- Chamfered Frame
- Chamfered or sculptured beading
- 28mm glazing and beading
- Concealed drainage available
- Internally Glazed
- Espagnolette Bolt Locking available
- 5 Colour Options
- Integral gaskets
- Available with BSI "A" & "C" ratings*

Trinity 70S

Trinity 70S offer all the advantages of the 70mm system with the added advantage of a fully sculptured frame.

The 70S frame is fully sculptured on both sides offering a more traditional finish, and is further complemented by fully sculptured beading. 70S frames are suitable for both new build and replacement frames, and offers you extra width in comparison to 60mm frames.

Available in casement windows, Tilt N Turns, mini-French windows and special frames.

- 70mm Profile
- Fully sculptured frame
- Sculptured beading
- 28mm glazing and beading
- Concealed drainage available
- Internally Glazed
- Espagnolette Bolt Locking available
- Integral gaskets
- Available with BSI "A" rating*

"Trinity 70C... allowing extra frame width, with a smooth finish"



"Trinity 70S... allowing extra frame width, with a shaped finish"



Window Types and Styles

Frame, Glass and Colour Options

Casements

Casement windows are the most popular style of window due to their versatility, and are ideal for new builds and any direct window replacement.

Casement windows are available in a range of styles, shapes and colour options. The range includes fixed light frames, side and top hung openings, and bay windows.



Specials

Trinity Specials make a unique addition to your home. Our investment in top of the range machinery ensures that frames can be manufactured to any shape.

Example of shapes available:

- Porthole windows
- Apex windows
- Gothic Arches
- Arched Tilt 'n' Turns
- Vertical Sliders with arched head



Window Styles

Below is an example of the window styles available. We manufacture to practically any size, shape or style... so the choice is yours.

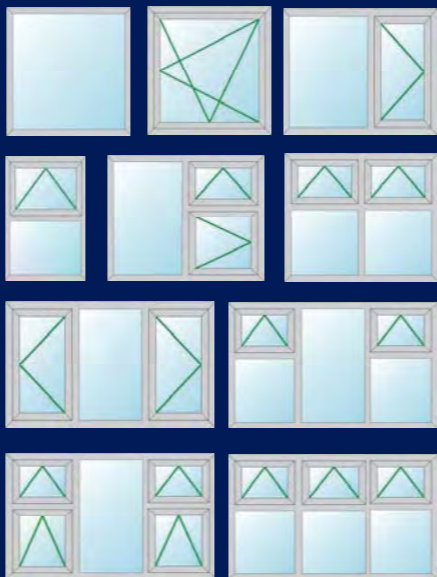

Please contact us for further style options

Window Frame Elements:

- Profile** – PVCu frame, available in 60mm and 70mm profile
- Sash** – the opening part of the frame, options include a top opening sash or side opening sash
- Glazing Unit** – 24mm or 28mm double glazing units available
- Beading** – secures glazing unit into frame. Available in sculptured or chamfered finish to match frame profile
- Gasket** – the rubber material added to profile to cushion glazing unit. Gaskets are integrated and colour co-ordinated
- Hinge** – several hinge options available depending on the type/profile of window
- Trickle Vent** – (optional) allows for air intake
- Drainage Caps** – caps fitted over drainage holes to allow water drainage. Concealed drainage also available
- Handle** – operates window locking system. Espagnolette locking system also available
- Transom** – the profile rail that runs horizontally within a window frame (ie: left to right)
- Mullion** – the profile rail that runs vertically within a window frame (ie: top to bottom)

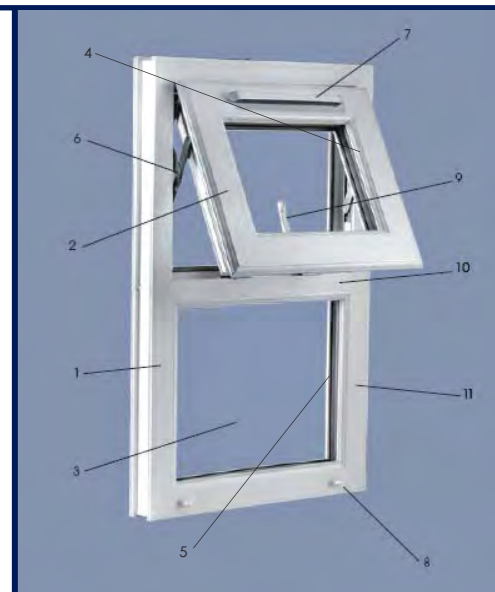

Vertical Sliding Sash

The vertical sliding sash window range combines the elegance of traditional sash windows with the benefits of PVCu.

Suitable for replacing existing timber sliders in period buildings and to new builds seeking to capture a traditional feel. The traditional style can be enhanced with the addition of georgian or astrical bars and decorative horns. Available in white, oak, cream and black.



French Windows

Brighten up your home with French windows. The opening allows unrestricted access and provides maximum ventilation.



Tilt N Turns

Tilt 'n' Turns are versatile, secure and easy to operate. The tilt position allows for ventilation, and the side hung facility allows for full opening into the room.



Profile Finish



Obscure Glass Options:



Colour Options:



	Standard/Stock Colour		Non-Stock Colour	
	Colour on White	Colour on Colour	Colour on White	Colour on Colour
Walnut		60C		
Natural		60C		
Oak	60 & 70	60 & 70		
Rosewood	70C	70C		
Mahogany	60	60		
Whitegrain		60C		
Cream		60C	60C	

	Standard/Stock Colour		Non-Stock Colour	
	Colour on White	Colour on Colour	Colour on White	Colour on Colour
Red	60C			
Blue	60C			
Green	60C			
Silver			60C	
Charcoal			60C	60C
Black	60C	60C		